

SONOFF

TX Ultimate

User manual V1.1

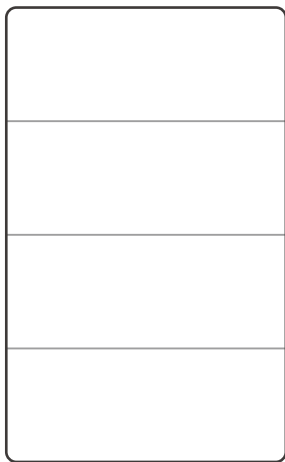

Smart Touch Wall Switch

产品介绍

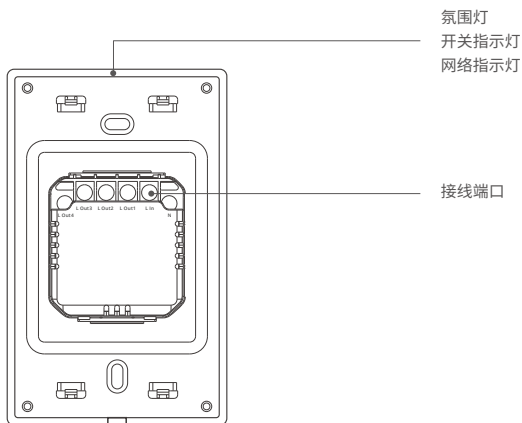
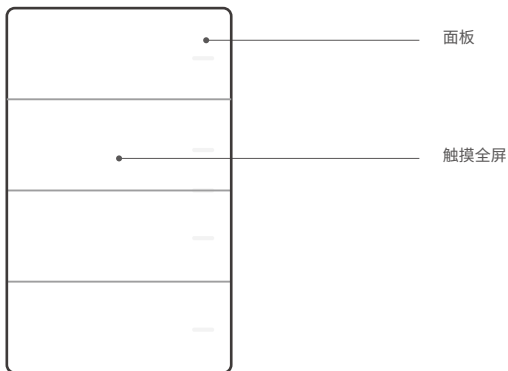

⚠ 设备重量<1Kg, 建议安装高度<2米。

指示灯状态及说明

指示灯名称	指示灯状态	状态说明
配网指示灯	处于“循环模式”	设备处于配对状态
网络指示灯	蓝色快闪一下	设备未连接路由器
	蓝色快闪两下	设备已连接路由器，但未连接云端

操作手势说明

手势	动作说明	主要作用
短按	手指快速点击面板	手动开启/关闭相应通道、APP场景触发条件
长按	手指长按面板5秒以上	使设备进入配网状态
划动	手指在面板上划动，划动距离超过面板范围50% <ul style="list-style-type: none"> • T5-120 横装支持左滑/右滑 • T5-120 竖装支持上滑/下滑 	APP场景触发条件
多指触摸	多根手指同时触碰面板	手动开启/关闭氛围灯

1. 横装

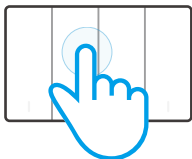

短按

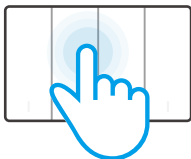

长按

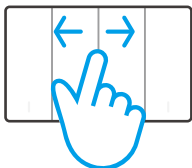

划动

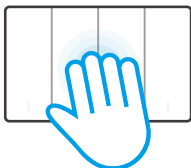

多指触摸

2. 竖装

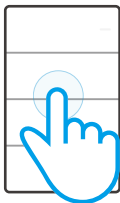

短按

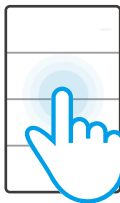

长按

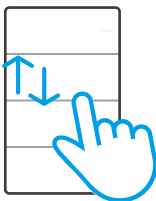

划动



多指触摸

功能特点

SONOFF TX Ultimate 是一款带LED灯的智能触摸墙面开关,开关时会伴随声音、灯光以及震动效果。在易微联APP配对成功后,可以在智能手机上远程控制开/关、切换氛围灯模式、设置定时或者智能场景。



远程控制



语音控制



智能场景



彩色氛围灯



振感触摸



声光反馈

设备安装

1. 断电

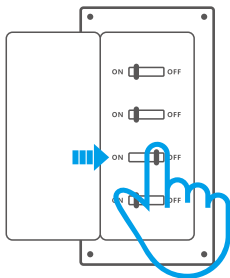

⚠ 设备安装、故障维修请由专业资质电工操作。切勿在设备通电时进行接线操作或触碰到接线端子,以免发生触电危险!

2. 接线

为确保电气安装的安全,必须在TX Ultimate前面安装符合国家安全标准额定电流为10A (T5-1C-120, T5-2C-120), 16A (T5-3C-120)的微型断路器 (MCB) 或漏电断路器 (RCBO)

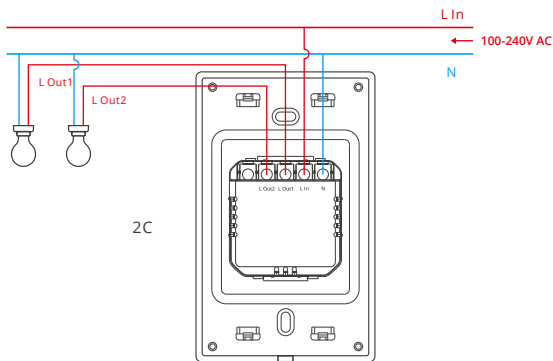
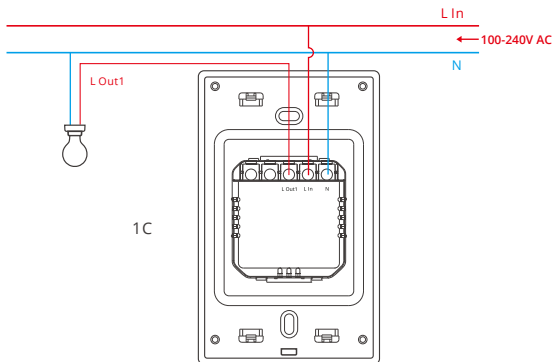

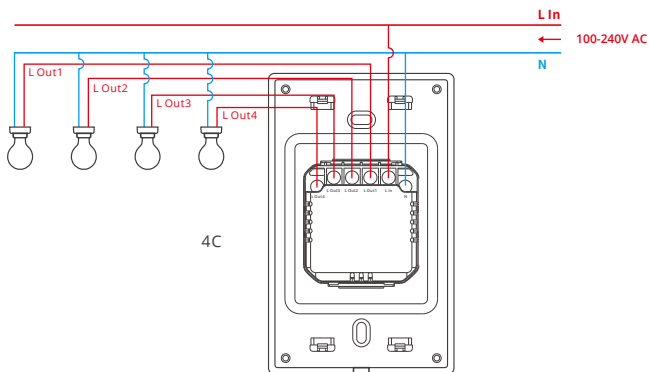
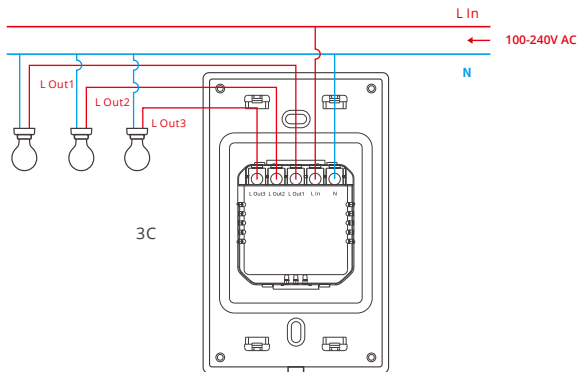

⚠ 确保线路接入无误。

易微联APP配网

1. 下载易微联App

请前往应用商店、Google Play Store或Apple App Store 搜索"易微联"进行下载。



2. 上电

通电后, 设备首次使用, 默认进入配网模式。设备指示灯呈“循环模式”。



ⓘ 30分钟内没有进行配网, 设备将退出配网模式。如需再次进入, 长触摸设备面板5秒直到设备指示灯呈“循环模式”即可。

3. 添加设备

点击“+”，选择“添加设备”，再根据 App 提示进行操作。

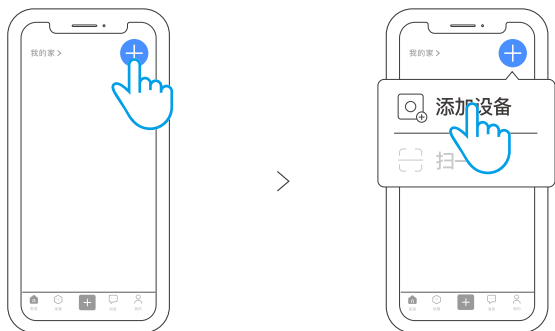

添加轻智能子设备

进入 eWeLink App 设备设置页面, 选择“轻智能子设备”再点击“添加”, 然后触发子设备, 即可添加成功。



产品参数

产品型号	T5-1C-120/T5-2C-120/T5-3C-120/T5-4C-120
输入	1C:100-240V ~ 50/60Hz Max 5A 2C:100-240V ~ 50/60Hz Max 10A 3C:100-240V ~ 50/60Hz Max 15A 4C:100-240V ~ 50/60Hz Max 16A
输出	1C:100-240V ~ 50/60Hz Max 5A 2C:100-240V ~ 50/60Hz Max 5A/Gang 10A/Total 3C:100-240V ~ 50/60Hz Max 5A/Gang 15A/Total 4C:100-240V ~ 50/60Hz Max 4A/Gang 16A/Total
LED负载	1C: 150W Max@240V,75W Max@100V 2C: 150W Max@240V/Gang,75W Max@100V/Gang 3C: 150W Max@240V/Gang,75W Max@100V/Gang 4C: 150W Max@240V/Gang,75W Max@100V/Gang
Wi-Fi	IEEE 802.11b/g/n 2.4GHz
工作温度	-10°C ~ 40°C
工作湿度	5% ~ 95%RH, 无冷凝
颜色	白色
外壳材料	PC +CRS
产品规格	120x74x39mm

Product introduction

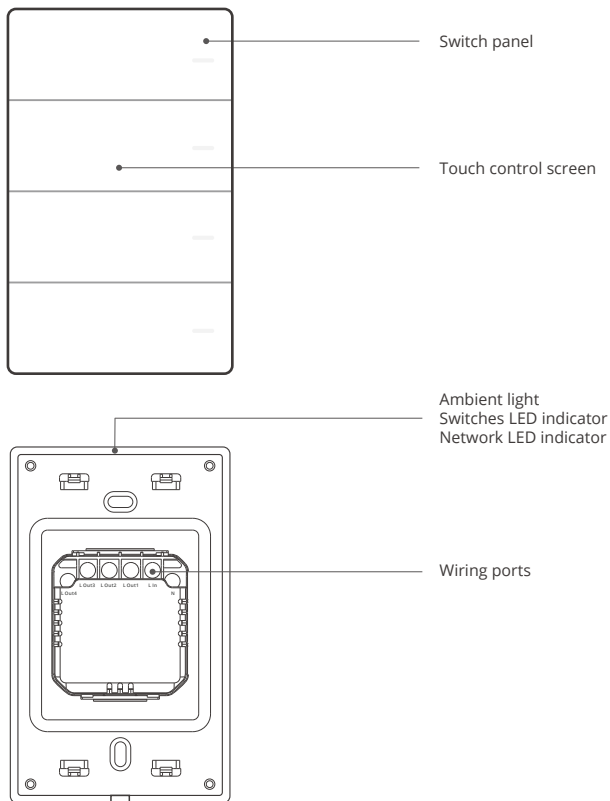

ⓘ The device weight is less than 1kg, and the recommended installation height is less than 2m.

LED Indicator status and instruction

LED indicators	LED indicator status	Instructions
Pairing LED indicator	In the "Cycle mode"	Device is in pairing mode
Network LED indicator	Flashes blue quickly once	Device is not connected to router
	Flashes blue quickly twice	Device is connected to the router but not to the cloud

Operation instruction

Operations	Instructions	Functions
Quick click	Click the switch panel quickly	Turn on/off the switches and trigger the smart scenes
Long press	Long press the switch panel for 5s	Make the device enter the pairing mode
Swipe	Swipe on the switch panel and ensure the swipe distance exceeds 50% of it <ul style="list-style-type: none"> • T5-120 supports left/right swipe • T5-120 supports up/down swipe 	Trigger the smart scene
Multi-point click	Multiple fingers click the switch panel	Turn on/off the ambient light manually

1. Horizontal installation

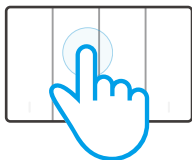

Quick click

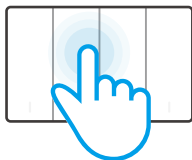

Long press

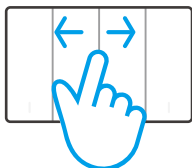

Swipe

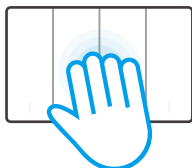

Multi-point click

2. Vertical installation

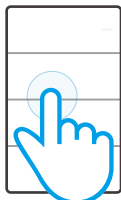

Quick click

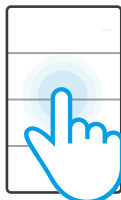

Long press

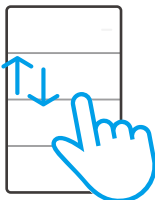

Swipe

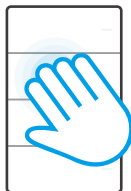

Multi-point click

Features

SONOFF TX Ultimate is a smart touch wall switch with LED lights which will produce sound, light and vibration effects when it is turned on/off. After adding in the eWeLink App, you can remote control on/off, switch the ambient lighting modes, set timer and smart scene on the phone.



Remote Control



Voice Control



Smart Scene



Ambient Lighting Mode



Touch Vibration



Light Effects

Installation

1. Power off

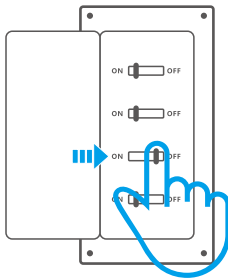

⚠ Please install and maintain the device by a professional electrician. To avoid electric shock hazard, do not operate any connection or contact the terminal connector while the device is powered on!

2. Wiring instruction

To ensure the safety of your electrical installation, it's essential either a Miniature Circuit Breaker (MCB) or a Residual Current Operated Circuit Breaker (RCBO) with an electrical rating of 10A (T5-1C-120, T5-2C-120), 16A (T5-3C-120) has been installed before the TX Ultimate.

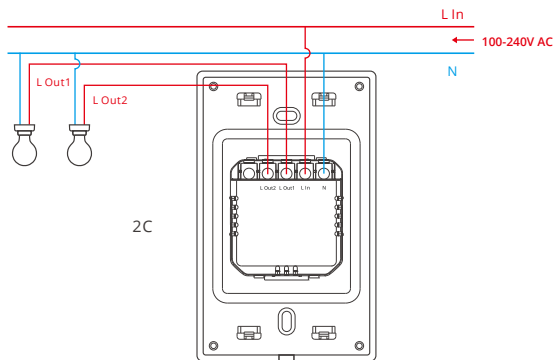
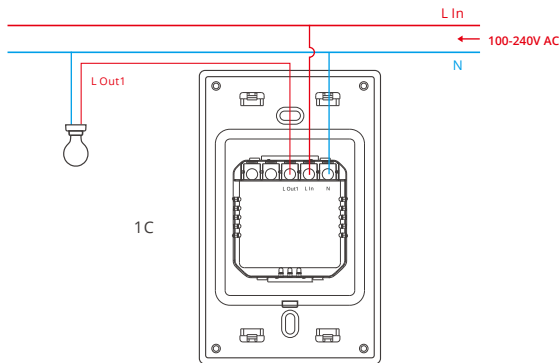

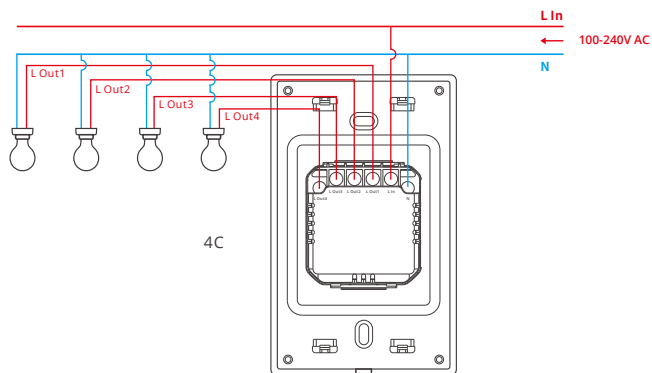
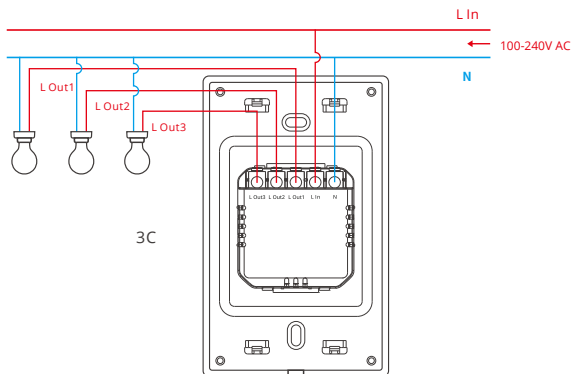

⚠ Make sure all wires are connected correctly.

eWeLink App Pairing

1. Download the eWeLink App

Please download the "eWeLink" App from Google Play Store or Apple App Store.



2. Power on

After powering on, the device will enter the Bluetooth pairing mode by default during the first use and the LED frame light will light in the "Cycle mode".



- ⚠ The device will exit the pairing mode when it doesn't be paired successfully within 10mins. If you want to access the pairing mode again, touch the wall switch panel for 5s until the LED frame light lights in the "Cycle mode".

3. Add device

Tap "+" and select "Add Device", then operate following the prompt on the App.

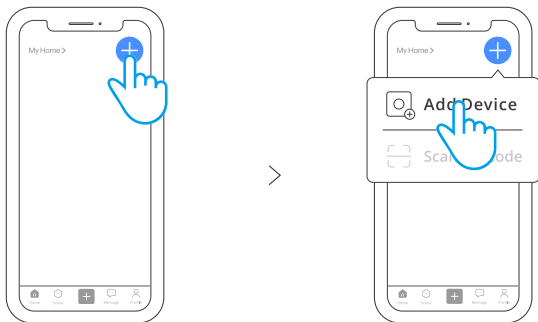

Add eWeLink-Remote Sub-devices

Enter the Device Settings page on the eWeLink App, select "eWeLink-Remote sub-devices" and tap "Add", then trigger the sub-device to add it successfully.

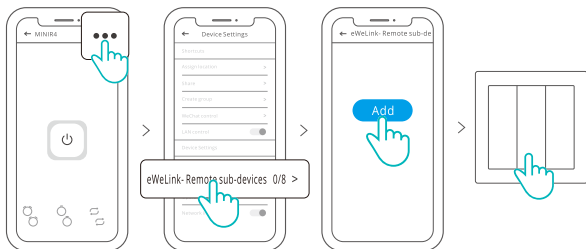

Specifications

Model	T5-1C-120/T5-2C-120/T5-3C-120/T5-4C-120
Input	1C:100-240V ~ 50/60Hz Max 5A 2C:100-240V ~ 50/60Hz Max 10A 3C:100-240V ~ 50/60Hz Max 15A 4C:100-240V ~ 50/60Hz Max 16A
Output	1C:100-240V ~ 50/60Hz Max 5A 2C:100-240V ~ 50/60Hz Max 5A/Gang 10A/Total 3C:100-240V ~ 50/60Hz Max 5A/Gang 15A/Total 4C:100-240V ~ 50/60Hz Max 4A/Gang 16A/Total
LED load	1C: 150W Max@240V,75W Max@100V 2C: 150W Max@240V/Gang,75W Max@100V/Gang 3C: 150W Max@240V/Gang,75W Max@100V/Gang 4C: 150W Max@240V/Gang,75W Max@100V/Gang
Wi-Fi	IEEE 802.11b/g/n 2.4GHz
Working temperature	-10℃ ~ 40℃
Working humidity	5% ~ 95%RH, non-condensing
Color	White
Casing material	PC +CRS
Dimension	120x74x39mm

FCC Compliance Statement

This device complies with part 15 of the FCC Rules. Operation is subject to the following two conditions:

- (1) This device may not cause harmful interference, and
- (2) This device must accept any interference received, including interference that may cause undesired operation.

2.Changes or modifications not expressly approved by the party responsible for compliance could void the user's authority to operate the equipment.

Note: This equipment has been tested and found to comply with the limits for a Class B digital device, pursuant to part 15 of the FCC Rules. These limits are designed to provide reasonable protection against harmful interference in a residential installation. This equipment generates, uses and can radiate radio frequency energy and, if not installed and used in accordance with the instructions, may cause harmful interference to radio communications. However, there is no guarantee that interference will not occur in a particular installation. If this equipment does cause harmful interference to radio or television reception, which can be determined by turning the equipment off and on, the user is encouraged to try to correct the interference by one or more of the following measures:

- Reorient or relocate the receiving antenna.
- Increase the separation between the equipment and receiver.
- Connect the equipment into an outlet on a circuit different from that to which the receiver is connected.
- Consult the dealer or an experienced radio/TV technician for help.

FCC Radiation Exposure statement:

This equipment complies with FCC radiation exposure limits set forth for an uncontrolled environment. This equipment should be installed and operated with minimum distance of 20 cm between the radiator and your body. This transmitter must not be co-located or operating in conjunction with any other antenna or transmitter.

ISED Notice

This device contains licence-exempt transmitter(s)/receiver(s) that comply with Innovation, Science and Economic Development Canada's licence-exempt RSS(s). Operation is subject to the following two conditions:

(1) This device may not cause interference.

(2) This device must accept any interference, including interference that may cause undesired operation of the device.

This Class B digital apparatus complies with Canadian ICES-003.

This device complies with RSS-247 of Industry Canada.

Operation is subject to the condition that this device does not cause harmful interference.

L'émetteur/récepteur exempt de licence contenu dans le présent appareil est conforme aux CNR d'Innovation, Sciences et Développement économique Canada applicables aux appareils radio exempts de licence. L'exploitation est autorisée aux deux conditions suivantes :

(1) L'appareil ne doit pas produire de brouillage;

(2) L'appareil doit accepter tout brouillage radioélectrique subi, même si le brouillage est susceptible d'en compromettre le fonctionnement.

Cet appareil numérique de la Classe B conforme à la norme NMB-003 du Canada.

Cet appareil est conforme à la norme RSS-247 d'Industrie Canada. Le fonctionnement est soumis à la condition que cet appareil ne provoque pas d'interférences nuisibles.

ISED Radiation Exposure Statement

This equipment complies with ISED radiation exposure limits set forth for an uncontrolled environment.

This equipment should be installed and operated with minimum distance of 20 cm between the radiator and your body.

This transmitter must not be co-located or operating in conjunction with any other antenna or transmitter.

Cet équipement est conforme aux limites d'exposition aux rayonnements de la ISED établies pour un environnement non contrôlé.

Cet équipement doit être installé et fonctionner à au moins 20cm de distance d'un radiateur ou de votre corps.

Cet émetteur ne doit pas être co-localisé ou fonctionner en conjonction avec une autre antenne ou un autre émetteur.

SAR Warning

Under normal use of condition, this equipment should be kept a separation distance of at least 20cm between the antenna and the body of the user.

Dans des conditions normales d'utilisation, cet équipement doit être maintenu à une distance d'au moins 20 cm entre l'antenne et le corps de l'utilisateur.

WEEE Warning



WEEE Disposal and Recycling Information All products bearing this symbol are waste electrical and electronic equipment (WEEEas in directive 2012/19/EU) which should not be mixed with unsorted householdwaste. Instead, you should protect human health and the environment by handingover your waste equipment to a designated collection point for the recycling of waste electricaland electronic equipment, appointed by the government or local authorities. Correct disposaland recycling will help prevent potential negative consequences to the environment and human health. Please contact the installer or local authorities for more information about thelocation as well as terms and conditions of such collection points.

产品中有害物质的名称及含量

部件名称	有害物质					
	铅 (Pb)	汞 (Hg)	镉 (Cd)	六价铬 (Cr {VI})	多溴联苯 (PBB)	多溴二苯醚 (PBDE)
塑料件	o	o	o	o	o	o
电子元器件	x	o	o	o	o	o
包装盒	o	o	o	o	o	o
PCB板	o	o	o	o	o	o
五金件	o	o	o	o	o	o

本表格依据SJ/T 11364 的规定编制：

o: 表示该有害物质在该部件所有均质材料中的含量均在GB/T 26572规定的限量要求以下；

x: 表示该有害物质至少在该部件的某一均质材料中的含量超出GB/T 26572规定的限量要求。



Scatola	Scatola	Manuale	Neto
PAP 20	PAP 21	PAP 22	EVA 7
Carta	Carta	Carta	Plastica
RACCOLTA DIFFERENZIATA			
Verifica le disposizioni del tuo Comune. Separa le componenti e conferiscile in modo corretto.			

执行标准: GB/T 16915.2-2012

EU Declaration of Conformity

Hereby, Shenzhen Sonoff Technologies Co., Ltd. declares that the radio equipment type T5-1C-120, T5-2C-120, T5-3C-120, T5-4C-120 are in compliance with Directive 2014/53/EU. The full text of the EU declaration of conformity is available at the following internet address:

<https://sonoff.tech/usermanuals>

For CE Frequency:

Operation frequency Range:

2402-2480MHz(BLE)

802.11 b/g/n20: 2412-2472MHz(Wi-Fi),

802.11 n40: 2422-2462MHz(Wi-Fi)

RF Output Power:

BLE: ≤10dBm

Wi-Fi: ≤20dBm

SONOFF

Shenzhen Sonoff Technologies Co., Ltd.

3F & 6F, Bldg A, No. 663, Bulong Rd, Shenzhen, Guangdong, China

ZIP code: 518000

Website: sonoff.tech

MADE IN CHINA



FR

Cet appareil
se recycle

À DÉPOSER
EN MAGASIN



OU

À DÉPOSER
EN DÉCHÈTERIE



Points de collecte sur www.quefairedemesdechets.fr
Privilégiez la réparation ou le don de votre appareil !