









Legend:

 Digital	 I2C	 Other SERIAL
 Power	 SPI	 Analog
 Ground	 UART/USART	 PWM/Timer
 Main Part		







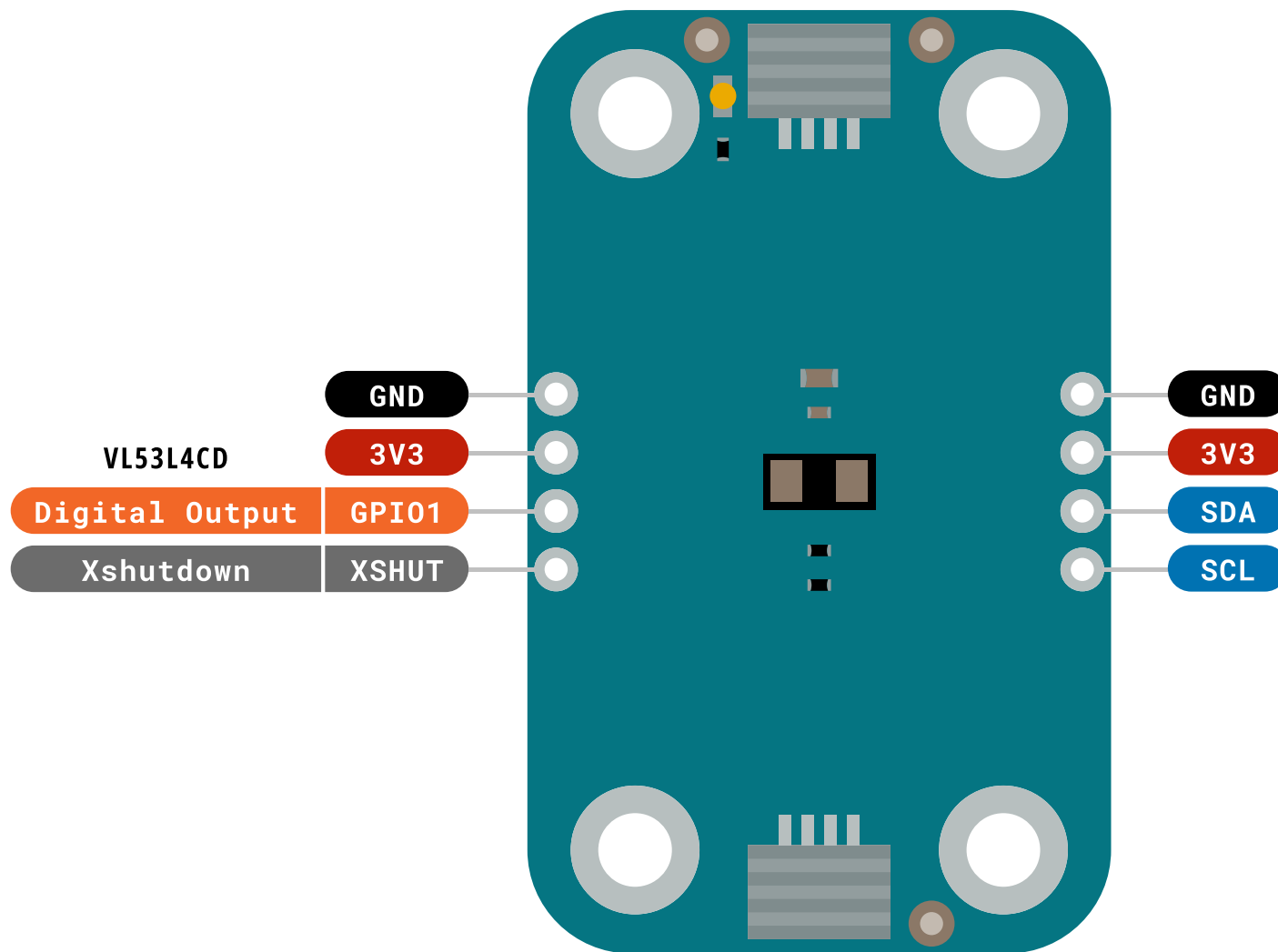





ARDUINO

Modulino Buzzer
 SKU code: ABX00108
 Pinout
 Last update: 18 Jun, 2024



Legend:







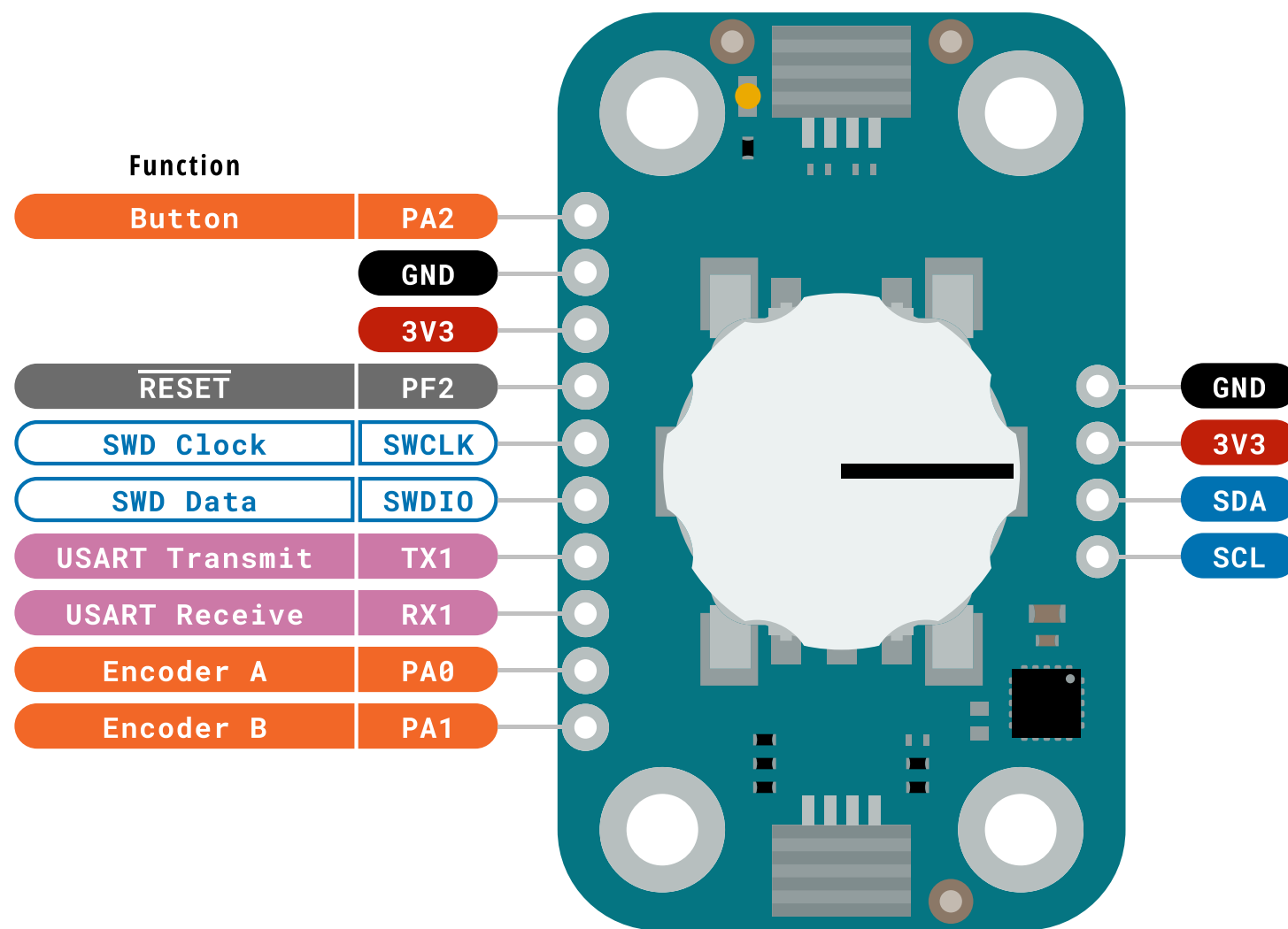



 Digital	 I2C	 Other SERIAL
 Power	 SPI	 Analog
 Ground	 Main Part	 UART/USART
 Analog	 PWM/Timer	



Modulino Distance
 SKU code: ABX00102
 Pinout
 Last update: 18 Jun, 2024



Legend:







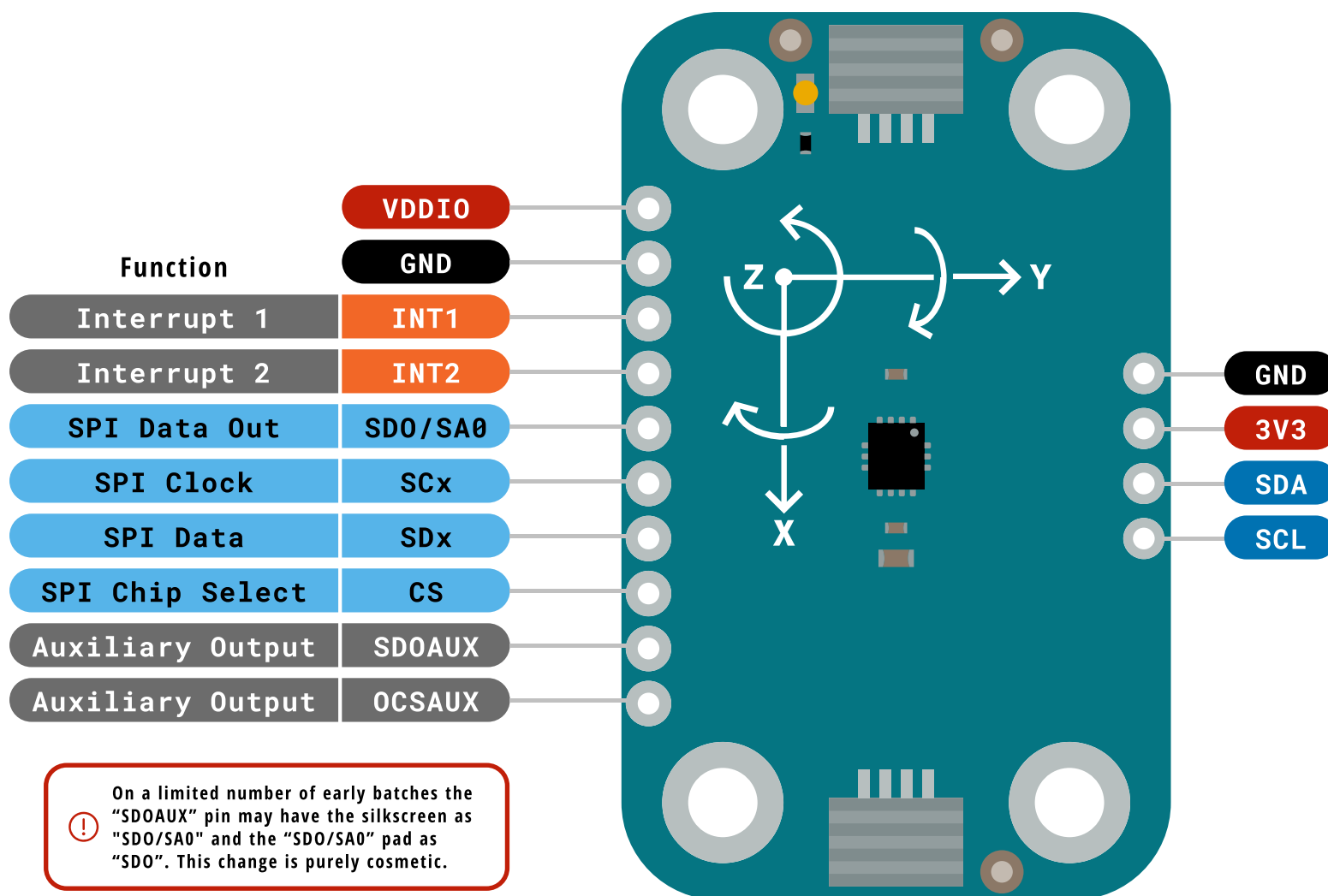



 Digital	 I2C	 Other SERIAL
 Power	 Analog	 Analog
 Ground	 Main Part	 PWM/Timer
	 SPI	
	 UART/USART	



Modulino Knob
 SKU code: ABX00107
 Pinout
 Last update: 18 Jun, 2024



Legend:

 Power	 Digital	 I2C	 Other SERIAL
 Ground	 Analog	 SPI	 Analog
	 Main Part	 UART/USART	 PWM/Timer







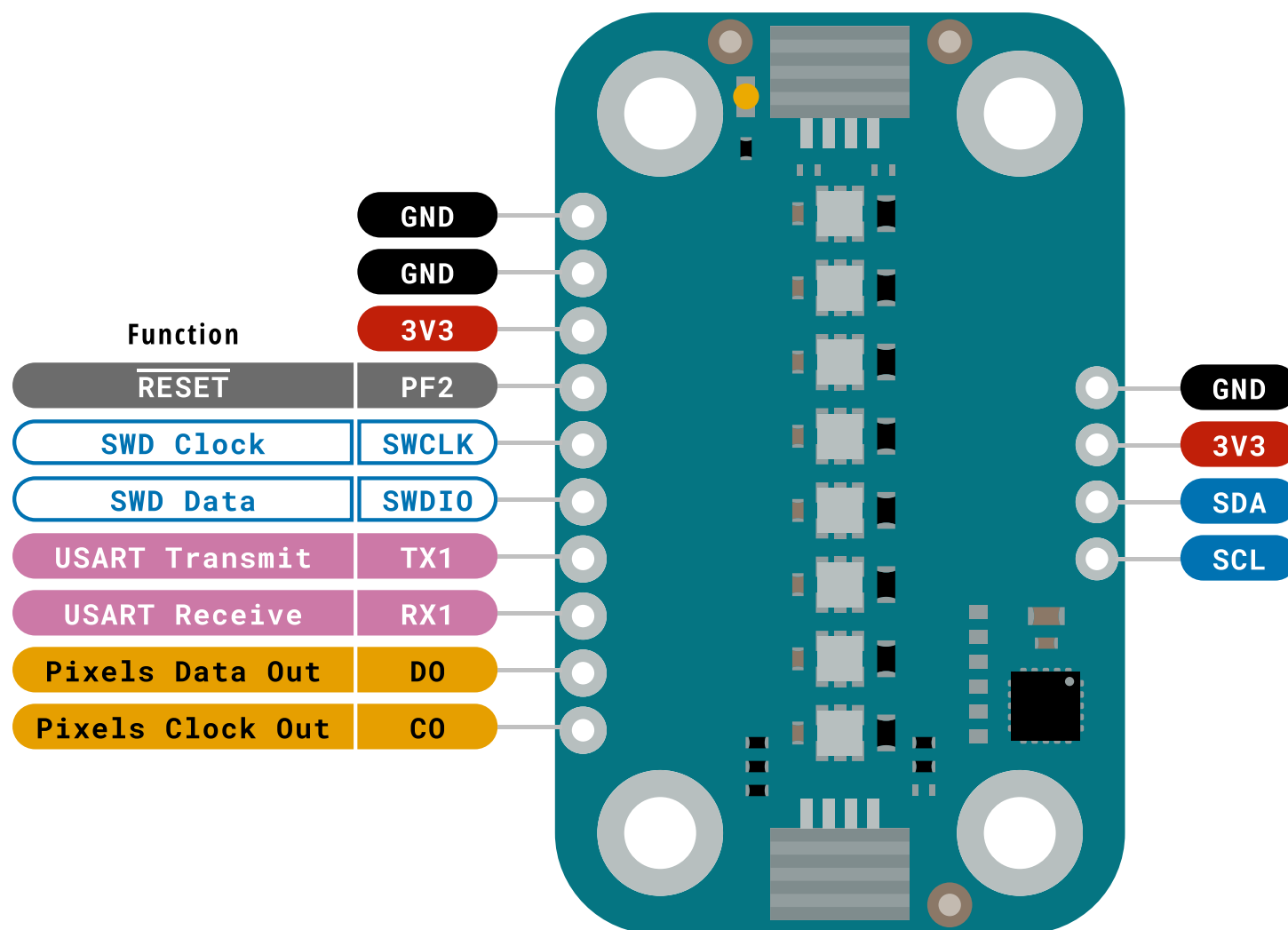





ARDUINO

Modugno Movement
 SKU code: ABX00101
 Pinout
 Last update: 18 Jun, 2024



Legend:

	Digital		I2C		Other SERIAL
	Power		SPI		Analog
	Ground		Main Part		PWM/Timer
			Analog		
			UART/USART		







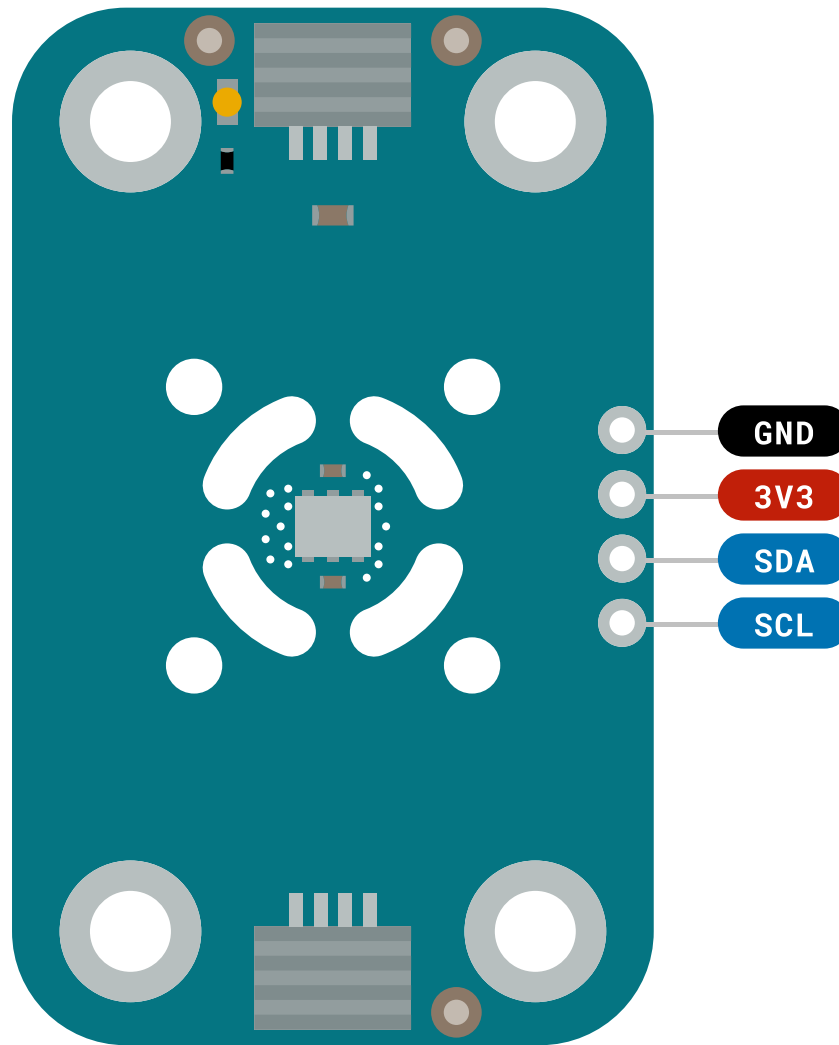

ARDUINO

Modulino Pixels
 SKU code: ABX00109
 Pinout
 Last update: 18 Jun, 2024



Legend:

 Power	 Digital	 I2C	 Other SERIAL
 Ground	 Analog	 SPI	 Analog
	 Main Part	 UART/USART	 PWM/Timer



Modulino Thermo
 SKU code: ABX00103
 Pinout
 Last update: 18 Jun, 2024

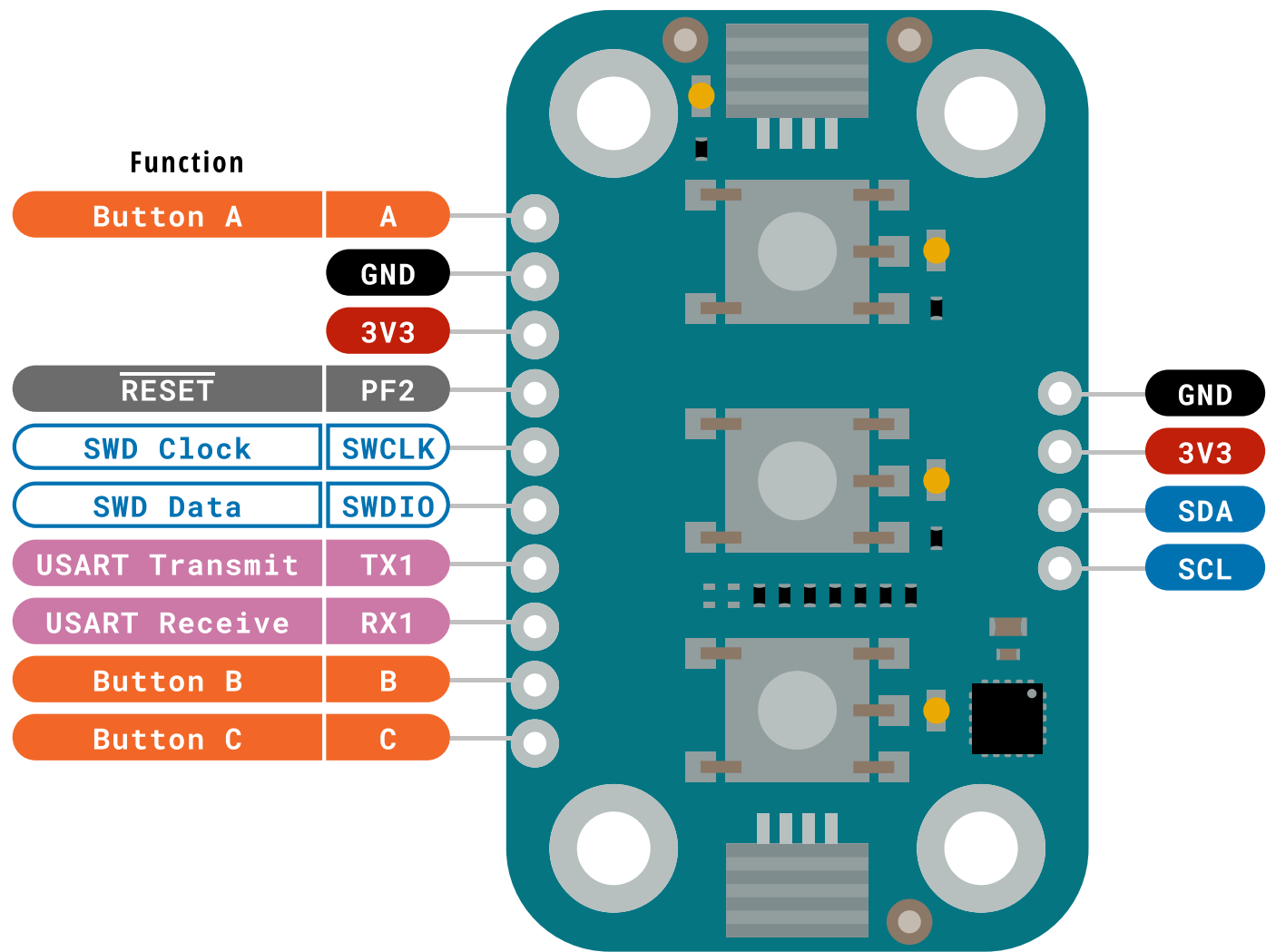

Legend:

- | | | |
|---------|------------|--------------|
| Digital | I2C | Other SERIAL |
| Power | SPI | Analog |
| Ground | Main Part | PWM/Timer |
| Analog | UART/USART | |



Modulino Buttons
 SKU code: ABX00110
 Pinout
 Last update: 18 Jun, 2024