

1010幻彩 贴片式发光二极管

特点 (Characteristics) :

- * 外观尺寸 (L/W/H) :1.0*1.0*0.8mm
Outline Dimensions (L / w / h): 1.0*1.0*0.8mm
- * 发光颜色及胶体:RGB/透明胶体
Luminous color and colloid:RGB/ transparent colloid
- * 环保工艺符合ROHS要求
Environmental protection products Complied With RoHS Directive
- * EIA规范标准包装
EIA standard packaging
- * 适用于SMT自动化贴片机
Suitable for SMT automatic production
- * 适用于回流焊制程
Suitable for reflow soldering process

应用领域 (Product application) :

- * LED全彩发光字灯串, LED全彩模组
LED full-color luminous character string, LED full-color module
- * LED幻彩软硬灯条, LED护栏管
LED magic color soft and hard light strip, LED guardrail tube
- * LED外观, 情景照明
LED appearance, scene lighting
- * LED点光源, LED像素屏
LED point light source, LED pixel screen
- * LED异形屏
LED special-shaped screen
- * 各种电子产品, 电器设备跑马灯
All kinds of electronic products and electrical equipment marquee



目录

Catalogue

电性参数	
Electrical Characteristics.....	3
典型特性曲线	
Typical Characteristic Curves.....	5
可靠性实验	
Reliability Test Items And Conditions.....	6
外形尺寸	
Outline Dimensions.....	7
包装	
Packaging.....	8
焊接指导	
Guideline for Soldering.....	10
使用注意事项	
Precautions.....	12

电性参数

Electrical Characteristics

◇极限参数（温度=25℃）：Absolute Maximum Ratings (Temperature=25℃):

参数 parameter	符号 Symbol	范围 Range	单位 unit
电压电压 Voltage Voltage	VDD	3.5~+5.5	V
逻辑输入电压 Logic input voltage	VIN	-0.4~VDD+0.4	V
工作温度 working temperature	Topt	-40~+150	℃
储存温度 Storage temperature	Tstg	-55~+150	℃
OUT R/G/B端口耐压 OUT R/G/B port withstand voltage	BVout	16	V
ESD耐压 ESD withstand voltage	VESD	>2K	V
灰度 Grayscale	---	256	级

光电参数（温度=25℃）：Electro-Optical Characteristics (Temperature=25℃):

参数 parameter	符号 Symbol	颜色 colour	测试条件 Test conditions	最小 Min	典型 Typ	最大 Max	单位 Unit
光强 light intensity	IV	红red	IF = 20mA	/	200	/	mcd
		绿green	IF = 20mA	/	800	/	
		蓝blue	IF = 20mA	/	300	/	
半光强视角 Half intensity viewing angle	2θ1/2	/	IF = 20mA	/	120	/	deg
主波长 Dominant wavelength	λD	红red	IF = 20mA	620	/	625	nm
		绿green	IF = 20mA	520	/	530	
		蓝blue	IF = 20mA	465	/	475	

亮度分档:

Brightness grading:

颜色 Colour	代码 Code	典型值 Typ	单位 Unit	测试条件 Test conditions
红red	P00	200	mcd	IF=20mA
绿green	P06	800		
蓝biue	P01	300		

波长分档:

Wavelength grading:

颜色 Colour	代码 Code	最小值 Min	最大值 Max	单位 Unit	测试条件 Test conditions
红red	HR02	620	625	nm	IF=20mA
绿green	HG52	520	530		
蓝biue	HB34	465	475		

电气特性（除非另有说明，VDD=5V, Ta=25℃）

Electrical characteristics (unless otherwise specified, VDD=5V, Ta=25 °C)

参数 parameter	符号 Symbol	测试条件 Test conditions	最小 Min	典型 Typ	最大 Max	单位 Unit
芯片工作电压 Chip operating voltage	VDD	---	2.5	---	5.5	V
静态电流 Quiescent current	IDD	VDD=4.5V, Iout“OFF”	---	0.35	---	mA
输入信号阈值电压 Input signal threshold voltage	VIH	VDD=5V, 调节DIN输入电平	2.8	---	---	V
	VIL	VDD=5V, adjust DIN input level	---	---	1.6	V
DOUT输出电流 DOUT output current	IOH	DOUT输出高, 串接10Ω电阻至 DOUT output is high, and 10 Ω resistance is connected in series to	---	-35	---	mA
DOUT灌电流 DOUT perfusion current	IOL	DOUT输出低, 电源对DOUT灌电流 The output of DOUT is low, and the power supply injects current to DOUT	---	35	---	mA
OUT R/G/B输出电流 OUT R/G/B output current	IOUT	VDD=5V, VDS=1.0V	---	5	---	mA
OUT R/G/B恒流拐点电压 OUT R/G/B constant current knee point voltage	VDS-S	IOUT=5mA	---	0.6	---	V
OUT R/G/B输出电流变化量 OUT R/G/B output current change	%VS.VDS	IOUT=5mA, VDS=1.0~3.0V	---	0.5	---	%
	%VS.VDD	IOUT=5mA, VDD=4.5~5.5V	---	0.5	---	%
	%VS.TA	IOUT=5mA, Ta=-40~+85℃	---	5.0	---	%
OUT R/G/B端口漏电流 OUT R/G/B port leakage current	Ileak	VDS=14V, Iout“OFF”	---	---	1	uA

开关特性 (VCC=5V, Ta=25°C) :

Switch characteristics (VCC=5V, Ta=25 °C):

参数 parameter	符号 Symbol	测试条件 Test conditions	最小 Min	典型 Typ	最大 Max	单位 Unit
OUT R/G/B输出PWM 频率 OUT R/G/B output PWM frequency	fpwm	Lour=5mA, OUT端口串 接200Ω电阻至VDD Loop=5mA, OUT port is connected in series with 200 Ω resistance to VDD	---	1.0	---	KHz
信号传输延时 (注4) Signal transmission delay (Note 4)	tplh	DOUT端口对地负载电容 30pF, DIN至DOUT的信号 传输延时	---	67	---	ns
	tphl	Load capacitance of DOUT port to ground 30pF, signal transmission delay from DIN to DOUT	---	93	---	ns
DOUT转换时间 (注5) DOUT conversion time (Note 5)	tTLH	DOUT端口对地负载电容 30pF	---	15	---	ns
	tTHL	Load capacitance of DOUT port to ground 30pF	---	23	---	ns
OUT R/G/B转换时间 (注6) OUT R/G/B conversion time (Note 6)	tr	Lout R/B=5mA, OUT R/G/B端口串接200Ω电阻 至VDD, 对地负载电容	---	104	---	ns
	tf	Lout R/B=5mA, OUT R/G/B port is connected in series with 200 Ω resistance to VDD, and load capacitance to ground	---	298	---	ns

数据传输方式Data transmission mode

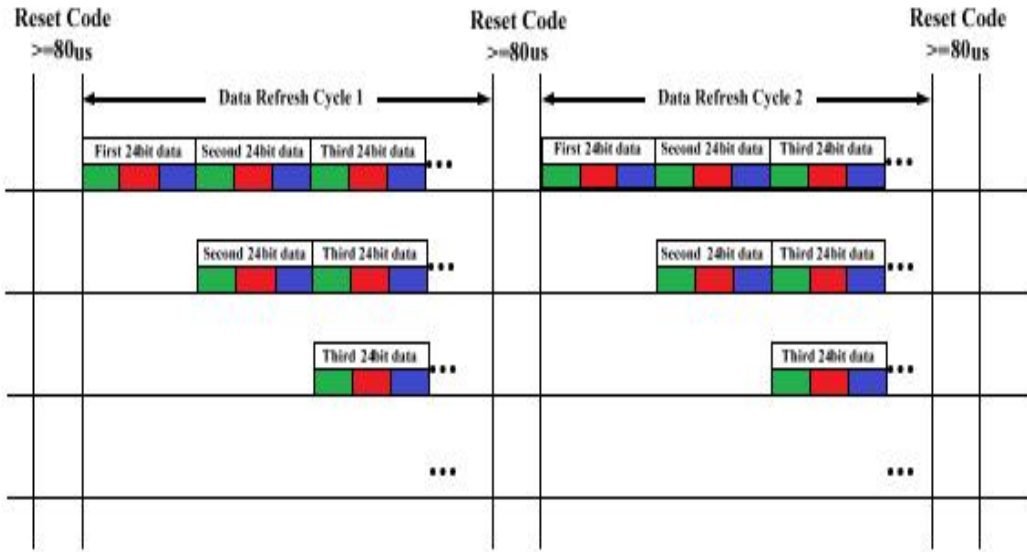

注：其中 D1 为 MCU 端发送的数据，D2、D3、Dn 为级联芯片自动整形转发的数据。

数据结构data structure



典型应用电路一：Typical application circuit I:

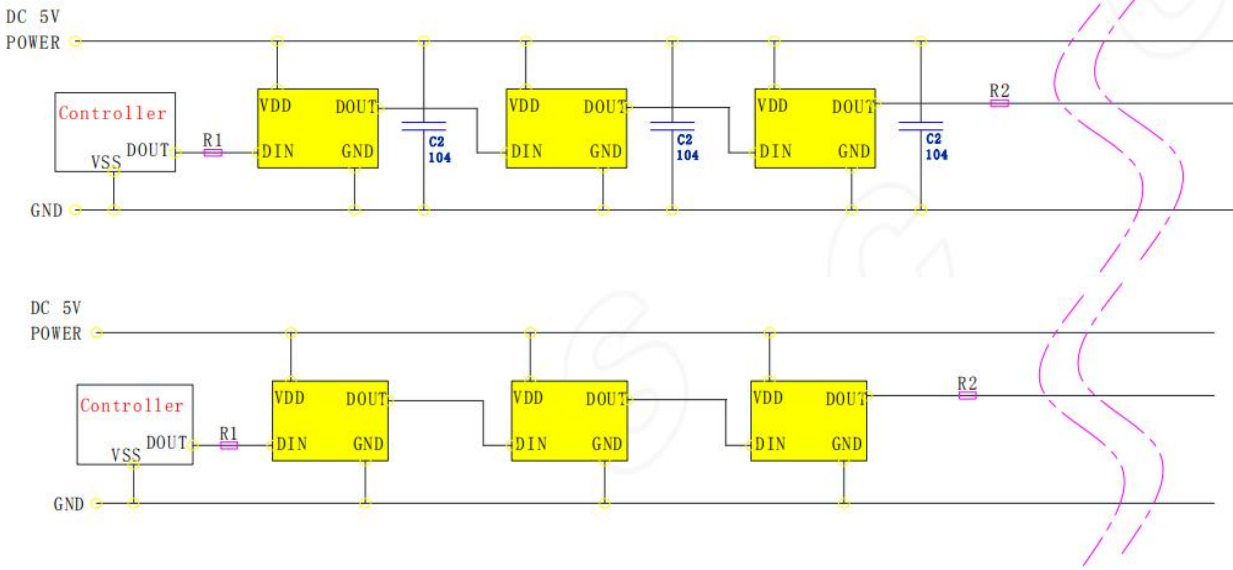

在实际应用电路中，为防止产品在测试时带电插拔产生的瞬间高压损伤IC内部电源及信号输入输出脚，应在信号输入及输出端串接保护电阻。此外，为了使各IC芯片间更稳定工作，各灯珠间的退偶电容则必不可少；

- 1.产品两端所并的退偶电容一般不建议省略；必须要省略的话，须确保所用电源符合上述应用电路二所述的要求；
- 2.产品的信号输入及输出端必需串接保护电阻R1/R2,因线材及传输距离不同，在信号线两端串接的保护电阻会略有不同；R1/R2的大小取决于级联灯珠的数量，级联数量越多，则R1/R2越小，灯珠间传输距离长，一般建议在20-2KΩ之间取值，通常建议取值在500欧左右；以实际使用情况定

In the actual application circuit, in order to prevent the IC internal power supply and signal input and output pins from being damaged by the instantaneous high voltage generated by live plugging during the test, protective resistors should be connected in series at the signal input and output terminals. In addition, in order to make the IC chips work more stably, the decoupling capacitor between the lamp beads is essential;

1. It is generally not recommended to omit the decoupling capacitance connected at both ends of the product; If it is necessary to omit, ensure that the power supply used meets the requirements described in the above application circuit II;
2. The signal input and output terminals of the product must be connected in series with the protection resistance R1/R2. Due to different wire materials and transmission distances, the protection resistance connected in series at both ends of the signal line will be slightly different; The size of R1/R2 depends on the number of cascaded lamp beads. The more the number of cascaded lamp beads, the smaller the R1/R2 and the longer the transmission distance between lamp beads. It is generally recommended to take a value between 20-2K Ω, and generally recommended to take a value around 500 Ω; Based on actual use

可靠性实验 Reliability experiment

测试项目 Test items	测试条件 Test conditions	测试次数 Number of tests	参考标准 Reference Standards	失效判定标准 Failure determination standard	失效LED数量 (PCS) Number of failure LEDs (PCS)
防潮等级 Moisture proof grade	1.回流焊最高温度=260℃,10秒, 2次回流焊; 2.回流焊之前存储条件: 30℃, 相对湿度=70%, 168H; 1. The maximum temperature of reflow soldering=260 °C, 10 seconds, two reflow soldering; 2. Storage conditions before reflow soldering: 30 °C, relative humidity=70%, 168H;	-	JEITA ED-4701 300.301	# 1	0/22
焊接信赖性 (无铅回流焊) Welding reliability (Lead free reflow soldering)	回流焊最高温度=245±5℃, 5秒 (无铅回流焊) Maximum reflow temperature=245 ± 5 °C, 5 seconds (lead-free reflow)	-	JEITA ED-4701 303 303A	# 2	0/22
冷热循环 thermal cycling	-40℃ 30分钟~25℃ 5分钟~ 100℃ 30分钟~25℃ 5分钟 -40 °C for 30 minutes to 25 °C for 5 minutes~ 100 °C for 30 minutes~25 °C for 5 minutes	300 个循环 300 cycles	JESD22-A104	# 1	0/22
冷热冲击 Thermal Shock	-35℃ 15分钟 转换时间3分钟 85℃ 15分钟 -35 °C for 15 minutes Conversion time: 3 minutes 85 °C for 15 minutes	300 个循环 300 cycles	JESD22-A106	# 1	0/22
高温存储 High temperature storage	Ta=100℃	1000 小时 300 cycles	JESD22-A103	# 1	0/22
低温存储 Low temperature storage	Ta=-40℃	1000 小时 300 cycles	JESD22-A119	# 1	0/22
常温老化 Normal temperature aging	Ta=25℃ IF=20mA	1000小时 300 cycles	JESD22-A108	# 1	0/22

失效标准
Failure criteria

标准 # standard	项目 project	测试条件 Test conditions	失效标准 Failure criteria
# 1	正向电压(V _F) Forward voltage (VF)	I _F =20mA	>U.S.L*1.1
	光强 (IV) Light intensity (IV)	I _F =20mA	<L.S.L*0.7
	反向电流(I _R) Reverse current (IR)	V _R =5V	>U.S.L*2.0
# 2	焊接可靠性 Welding reliability	/	锡膏覆盖焊盘比例小于95% The proportion of solder paste covering pads is less than 95%

外形尺寸

Outline Dimension

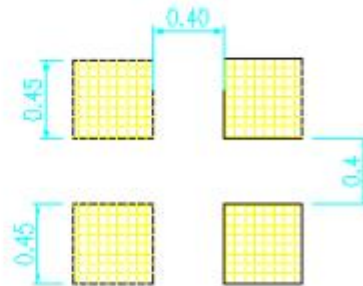
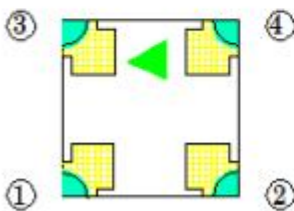
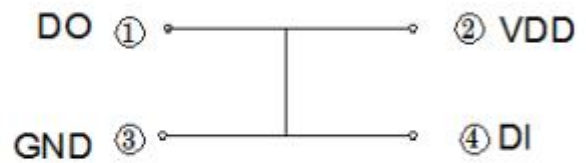
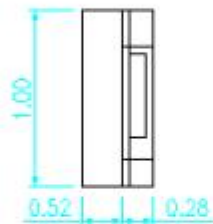
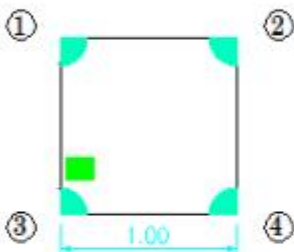

推荐焊盘图:

Suggest Soldering Pad Dimensions

备注: 1.单位: 毫米 (mm)

Remarks: 1 Unit: mm

2.公差: 如无特别标注则为±0.10mm

2.Tolerance: ± 0.10mm unless otherwise specified

序号 Serial No	符号 Symbol	管脚名 Pin name	功能描述 Function description
1	DOUT	数据输出 data output	控制数据信号输出 Control data signal output
2	VDD	电源 Power Supply	供电管脚 Power supply pin
3	GND	地 land	信号接地和电源接地 Signal grounding and power grounding
4	DIN	数据输入 data input	控制数据信号输入 Control data signal input

功能描述:Function description:

VDD 输入电压: 3.5V~5.5V

VDD input voltage: 3.5V~5.5V

OUT R/G/B 恒流值: 5mA

Output R/G/B Constant current value: 5mA

OUT R/G/B 上电状态: 默认关闭

OUT R/G/B power on state: off by default

OUT R/G/B 端口耐压: 10V

OUT R/G/B port withstand voltage: 10V

OUT R/G/B 输出灰度等级: 256 级

OUT R/G/B output gray level: 256

采用单线归零码 SID 数据协议

Adopt single line zero return code SID data protocol

同一帧显示数据同步刷新

Synchronous refresh of display data at the same frame

数据串行级联传输, 抗干扰能力强

Serial cascade transmission of data with strong anti-interference capability

信号传输速率: 800Kbps

Signal transmission rate: 800Kbps

集成驱动幻彩光源专用内置 IC

Special built-in IC for integrated driving magic light source

包装 (1)

Packaging (1)

载带与圆盘尺寸 Belt and disk dimensions

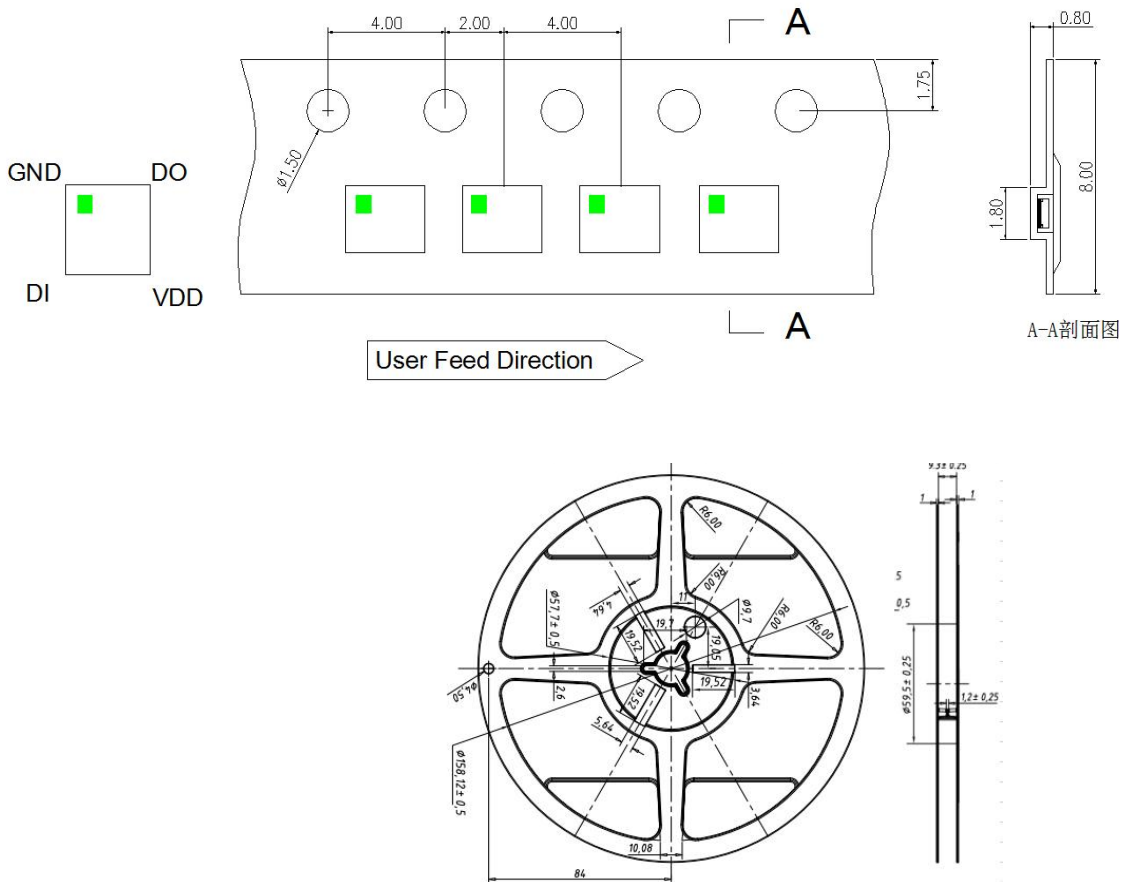

注:

1. 尺寸单位为毫米(mm)。
1. Size unit is mm (mm).
2. 尺寸公差是±0.1mm。
2. The dimensional tolerance is ± 0.1mm.

圆盘及载带卷出方向及空穴规格 Disk and carrier belt direction of roll and hole dimensions

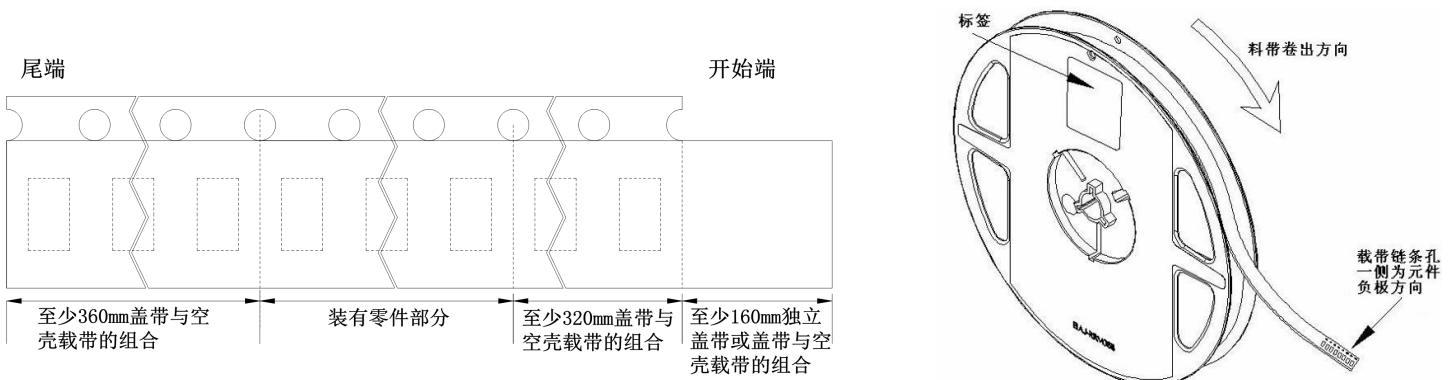

包装 (2)

Packaging (2)

◇ 防潮防静电包装 Moisture Proof and Anti-Electrostatic Foil Bag

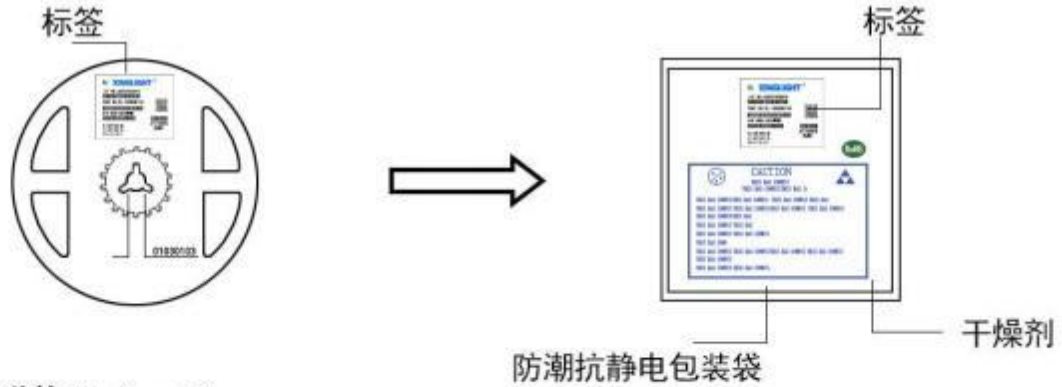

◇ 外包装箱 Cardboard Box

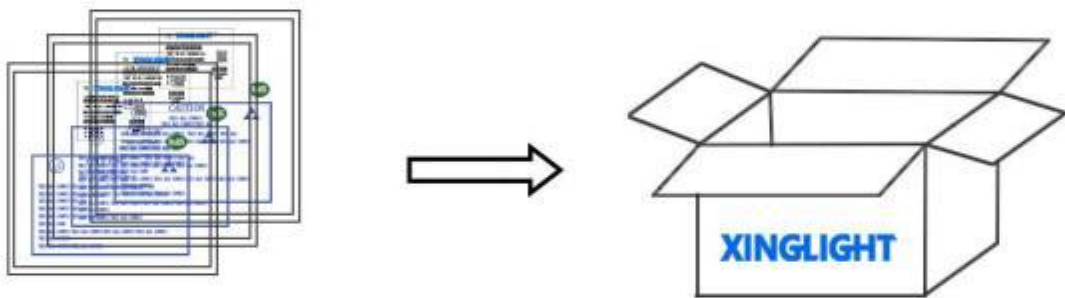

Capacity 5 or 10 reels per box (内箱容量: 50或100卷)

◇ 标签说明: Label Explanation

- LOT NO: 批次信息
- PART NO: 产品型号
- BIN CODE: 产品名称
- WL: 波长范围
- IV: 光强范围
- VF: 电压范围



焊接指导（1）

Guideline for Soldering (1)

1. 使用烙铁人手焊接

Hand Soldering

只建议在修理和重工的情况下使用手工焊接；推荐使用功率低于 30 W 的烙铁，焊接时烙铁的温度必须保持在 300℃ 以下，且每个电极只能进行一次焊接，每次焊接的持续时间不得超过 3 秒。

人手焊接过程中的不慎操作易引起 LED 产品的损坏，应当小心谨慎。

Manual welding is recommended only for repair and heavy industry situations. A soldering iron of less than 30W is recommended to be used in Hand Soldering. Please keep the temperature of the soldering iron under 300℃ while soldering. Each terminal of the LED is to go for less than 3 second and for one time only.

Be careful because the damage of the product is often started at the time of the hand soldering.

2. 回流焊接：推荐使用以下无铅回流焊接温度图进行。

Reflow Soldering: Use the conditions shown in the under Figure of Pb-Free Reflow Soldering.

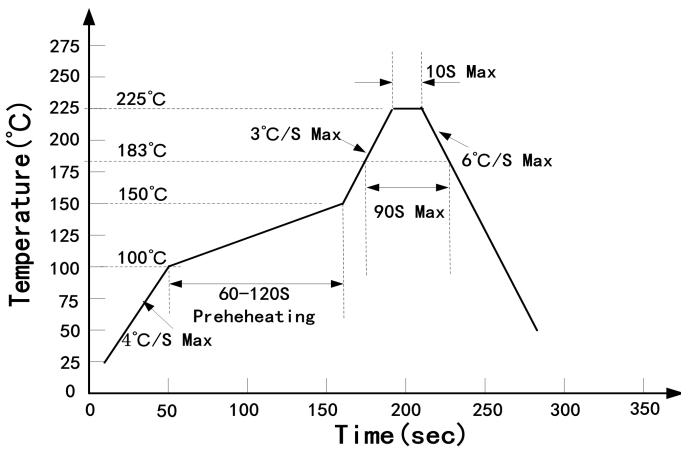

有铅制程 have lead process

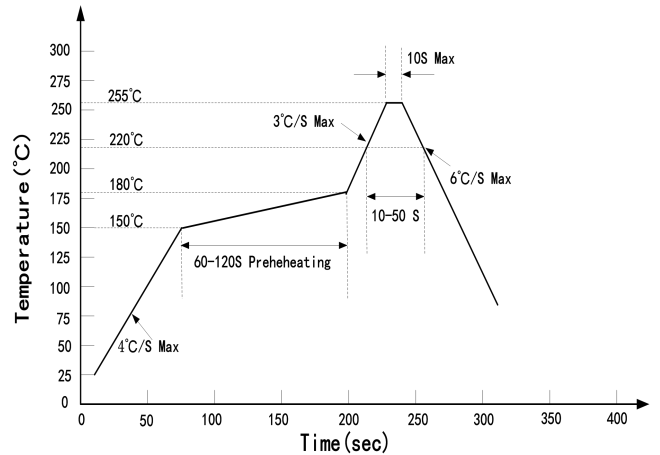

无铅制程 Lead-free process

- 回流焊接最多只能进行两次。

Reflow soldering should not be done more than two times.

- 在回流焊接升温过程中，请不要对 LED 施加任何压力。

Stress on the LEDs should be avoided during heating in soldering process.

- 在焊接完成后，待产品温度下降到室温之后，再进行其他处理。

After soldering, do not deal with the product before its temperature drop down to room temperature.

焊接指导 (2)

Guideline for Soldering (2)

3. 清洗:

Cleaning

在焊接后推荐使用酒精进行清洗，在温度不高于 30°C 的条件下持续 3 分钟，不高于 50°C 的条件下持续 30 秒。使用其他类似溶剂清洗前，请先确认使用的溶剂不会对 LED 的封装和环氧树脂部分造成损伤。

超声波清洗也是有效的方法，一般最大功率不应超过 300W，否则可能对 LED 造成损伤。请根据具体的情况预先测试清洗条件是否会对 LED 造成损伤。

It is recommended that alcohol be used as a solvent for cleaning after soldering. Cleaning is to go under 30°C for 3 minutes or 50°C for 30 seconds. When using other solvents, it should be confirmed beforehand whether the solvents will dissolve the package and the resin or not.

Ultrasonic cleaning is also an effective way for cleaning. But the influence of Ultrasonic cleaning on LED depends on factors such as ultrasonic power. Generally, the ultrasonic power should not be higher than 300W. Before cleaning, a pretest should be done to confirm whether any damage to LEDs will occur.

- * **注意:** 此一般指导原则并不适用于所有 PCB 设计和焊接设备的配置。具体工艺受到诸多因素的影响，请根据特定的 PCB 设计和焊接设备来确定焊接方案。
- * **Note:** This general guideline may not apply to all PCB designs and configurations of all soldering equipment. The technics in practise is influenced by many factors, it should be specialized base on the PCB designs and configurations of the soldering equipment..

使用注意事项 (1)

Precautions (1)

1. 贮存:

Storage

- 本产品使用密封防潮抗静电袋包装, 并附有干燥剂, 未开封的产品有一年的保存时间。

Moisture proof and anti-electrostatic package with moisture absorbent material is used, to keep moisture to a minimum.

- 开封前, 产品须存放在温度不高于 30°C, 湿度不高于 40%RH 的环境中。

Before opening the package, the product should be kept at 30°C or less and humidity less than 40% RH, and be used within a year.

- 开封后, 产品须存放在温度不高于 30°C, 湿度不高于 10%RH 的环境中, 且应该在 24 小时 (1天) 内使用完;且贴片后应尽快做焊接。建议工作环境为温度不高于 30°C, 湿度不高于 40%RH。

After opening the package, the product should be stored at 30°C or less and humidity less than 10%RH, and be soldered within 24 hours (1 day). And it should be welded as soon as possible after the patch. It is recommended that the product be operated at the workshop condition of 30°C or less and humidity less than 40%RH.

- 对于尚未焊接的 LED, 如果吸湿剂或包装失效, 或者产品没有符合以上有效存储条件, 烘焙可以起到一定的性能恢复效果。烘焙条件: (60±5) °C, 持续 24 小时。

If the moisture absorbent material has fade away or the LEDs have exceeded the storage time, baking treatment should be performed based on the following condition: (60±5)°C for 24 hours.

2. 静电:

Static Electricity

静电和电涌会导致产品特性发生改变, 例如正向电压降低等, 如果情况严重甚至会损毁产品。所以在使用时必须采取有效的防静电措施。

所有相关的设备和机器都应该正确接地, 同时必须采取其他防止静电和电涌的措施。使用防静电手环。防静电垫子, 防静电工作服、工作鞋、手套, 防静电容器, 都是有效的防止静电和电涌的措施; 严禁使用普通塑料制品。建议在作业过程中, 使用离子风扇来压制静电的产生。距离LED元件1英尺距离的环境范围内静电场电压小于100V。

Static electricity or surge voltage damages the LEDs. Damaged LEDs will show some unusual characteristic such as the forward voltage becomes lower, or the LEDs do not light at the low current. even not light.

All devices, equipment and machinery must be properly grounded. At the same time, it is recommended that wrist bands or anti-electrostatic gloves, anti-electrostatic containers be used when dealing with the LEDs. Using ordinary plastic products are strictly prohibited. It is recommended to use ion fans to suppress the static electricity generation during the operation. The static field voltage is less than 100V within the ambient range of 1 foot distance from the LED element.

使用注意事项 (2)

Precautions (2)

3. 设计建议:

Design Consideration

设计电路时，通过 LED 的电流不能超过规定的最大值，同时，还需使用保护电阻，否则，微小的电压变化将会引起较大的电流变化，可能导致产品损毁。

建议使用以下 (A) 电路，该电路能够很好的调节通过每个 LED 的电流；不推荐使用 (B) 电路，该电路在持续的电压驱动下，LED 的正向电压 (V_F) 发生变化，电流会随之而发生变化，可能使某些 LED 承受高于规定的电流值。

In designing a circuit, the current through each LED must not exceed the absolute maximum rating specified for each LED. In the meanwhile, resistors for protection should be applied, otherwise slight voltage shift will cause big current change, burn out may happen.

It is recommended to use Circuit A which regulates the current flowing through each LED rather than Circuit B. When driving LEDs with a constant voltage in Circuit B, the current through the LEDs may vary due to the variation in Forward Voltage (V_F) of the LEDs. In the worst case, some LED may be subjected to stresses in excess of the Absolute Maximum Rating.

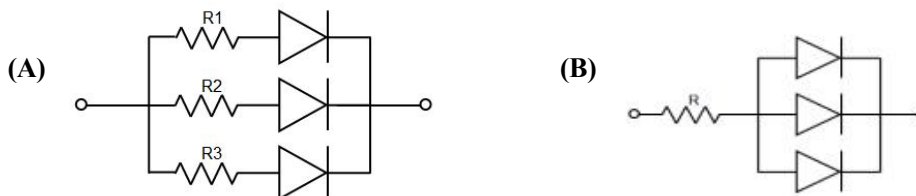

光电参数公差:

正向电压 V_F / V_F : $\pm 0.1V$

亮度 I_V / I_V : $\pm 15\%$

波长 λ / λ : $\pm 1nm$

LED 的特性容易因为自身的发热和环境的温度的改变而发生改变。温度的升高会降低 LED 的发光效率、影响发光颜色等，所以在设计时应充分考虑散热的问题。

Thermal Design is paramount importance because heat generation may result in the Characteristics decline, such as brightness decreased, Color changed and so on. Please consider the heat generation of the LEDs when making the system design.

使用注意事项 (3)

Precautions (3)

4. 其他事项:

Others

直接用手拿取产品不但会污染封装树脂表面，也可能由于静电等因素导致产品性能的改变。过度的压力也可能直接影响封装内部的管芯和金线，因此请勿对产品施加过度压力，特别当产品处于高温状态下，例如在回流焊接过程中。

When handling the product, touching the encapsulant with bare hands will not only contaminate its surface, but also affect on its optical characteristics. Excessive force to the encapsulant might result in catastrophic failure of the LEDs due to die breakage or wire deformation. For this reason, please do not put excessive stress on LEDs, especially when the LEDs are heated such as during Reflow Soldering.

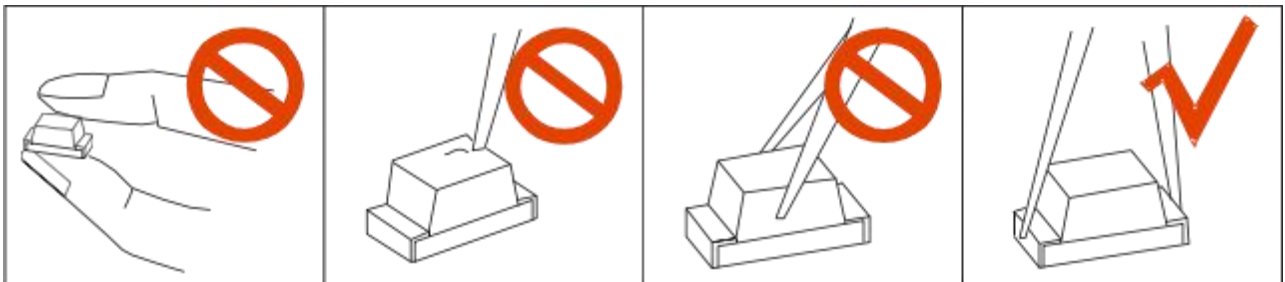

LED 的环氧树脂封装部分相当脆弱，请勿用坚硬、尖锐的物体刮、擦封装树脂部分。在用镊子夹取的时候也应当小心注意。

The epoxy resin of encapsulant is fragile, so please avoid scratch or friction over the epoxy resin surface. While handling the product with tweezers, do not hold by the epoxy resin, be careful.

5. 眼睛保护忠告:

Safety Advice For Human Eyes

LED 发光时，请勿直视发光光源，特别是对于一些光强较高的 LED，强光可能伤害你的眼睛。

Viewing direct to the light emitting center of the LEDs, especially those of great Luminous Intensity, will cause great hazard to human eyes. Please be careful.